

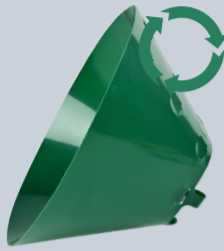











BUSTER Collars for optimal protection and successful recovery

Size and type of patient, personality, behaviour, and the actual procedure matters when choosing the optimal E-collar. Use below parameters as a guide to choose collars for your individual patients.

													
	BUSTER GREEN OCEAN COLLAR	BUSTER CLASSIC COLLARS	BUSTER CLIC COLLAR	BUSTER CLIC COLLAR, BRACHYCEPHALIC	BUSTER DESIGN COLLARS	BUSTER EASY COLLAR	BUSTER COMPLETE COLLAR	BUSTER QUICK COLLAR	BUSTER COMFORT COLLAR	BUSTER SOFT FLEX COLLAR, CUSHIONED	BUSTER FOAM COLLAR, CUSHIONED	BUSTER SOFT COLLAR, CUSHIONED	BUSTER INFLATABLE COLLARS
Highest protection	•	•	•	•	•	•	•	•	•	•	•	•	•
Highest comfort							•			•	•	•	•
Sustainability	•	•	•	•	•								
Full vision		•	•	•	•	•	•	•	•				•
Opaque	•	•								•	•	•	
Ease of use						•	•			•	•	•	•
Button closure						•							
Weave closure		•											
Clic closure	•		•	•	•				•				
Tie string closure										•		•	
Touch fastener closure							•	•			•		•

5 different closure systems

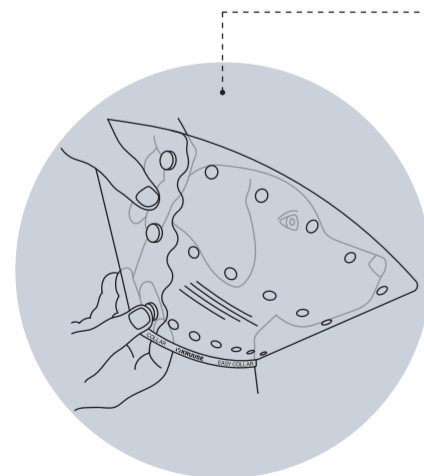

Button closure

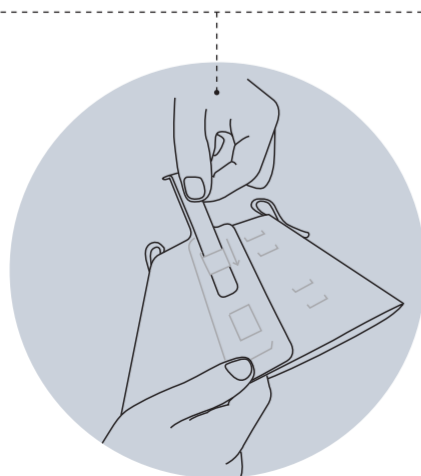

Weave closure

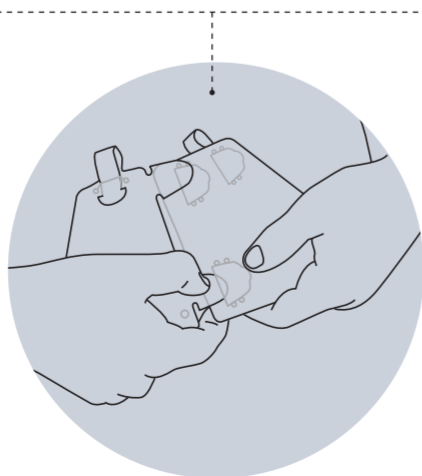

Clic closure

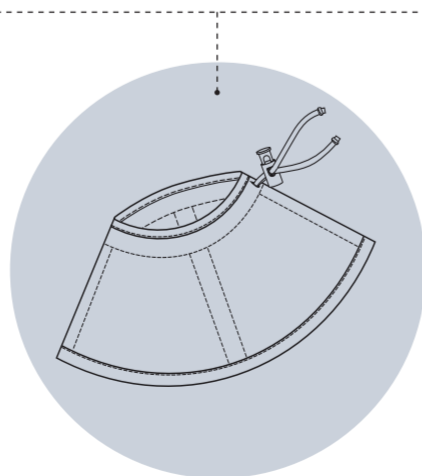

Tie string closure

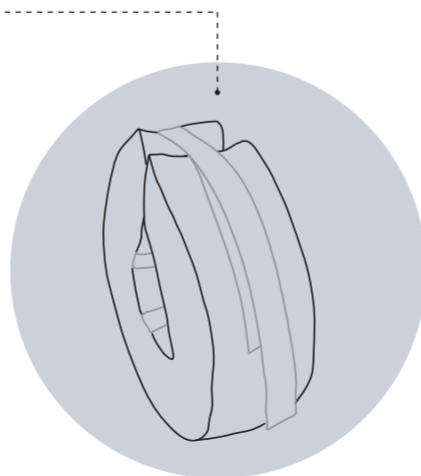

Touch fastener closure

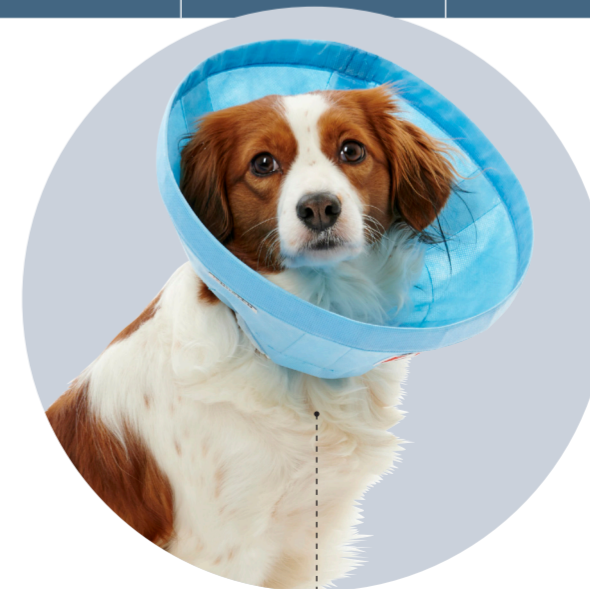

2-way protection